

LAPPSET®

PARKOUR







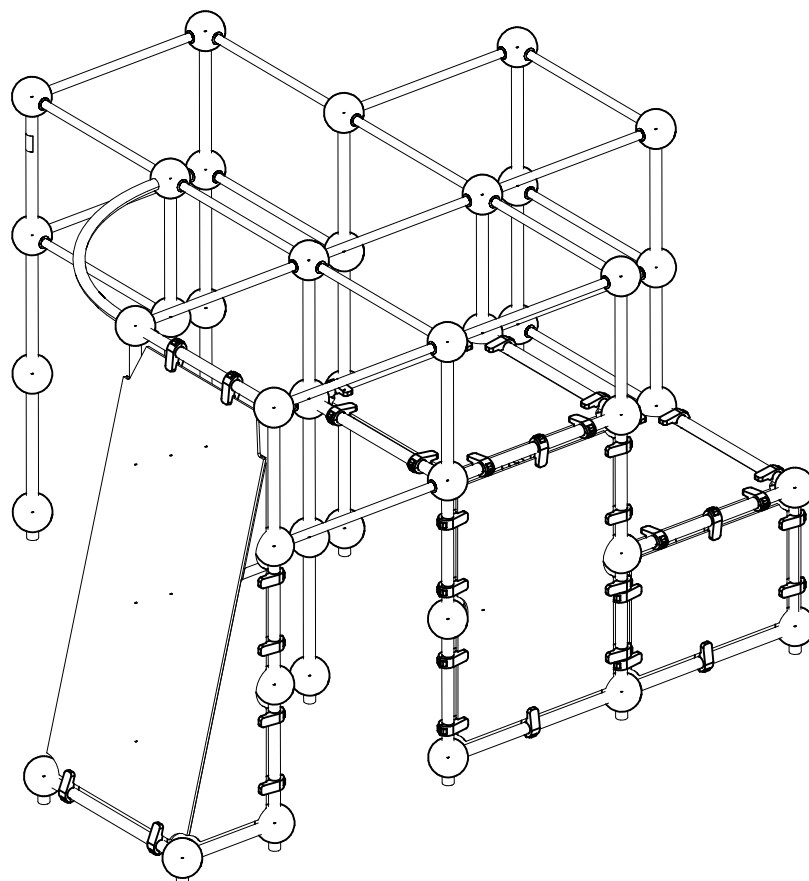



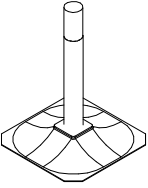

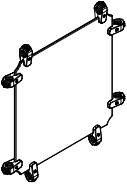

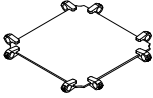

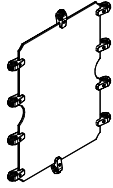

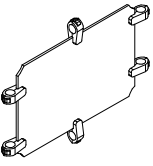

ASENNUSOHJE
MONTERINGSANSVISNING
INSTALLATION INSTRUCTION
AUFBAUANLEITUNG
NOTICE D'INSTALLATION

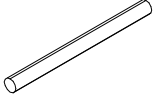
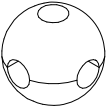
DATE: 19.3.2013

220524

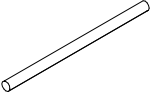
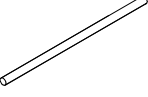

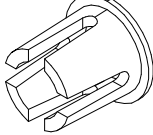
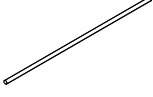
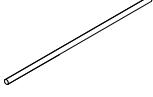
DATE: 19.3.2013

<p>701985</p>  <p>PCS 15</p> 	<p>702341</p>  <p>PCS 1</p> <p>90x50</p>	<p>703456</p>  <p>PCS 1</p> 	<p>703459</p>  <p>PCS 1</p> 	<p>703479</p>  <p>PCS 1</p> 	<p>703487</p>  <p>PCS 1</p> 
<p>703901</p>  <p>PCS 1</p> 	<p>902022</p>  <p>PCS 1</p> <p>L 710</p>	<p>902134</p>  <p>PCS 52</p> 	<p>902157</p>  <p>PCS 149</p> <p>60x60x2</p>	<p>902418</p>  <p>PCS 1</p>	<p>902424</p>  <p>PCS 10</p> <p>L 1034</p>
<p>904015</p>  <p>PCS 14</p> <p>Ø44.5x1034</p>	<p>904032</p>  <p>PCS 12</p> <p>L 2278</p>	<p>904100</p>  <p>PCS 44</p> <p>44.5-60.3</p>	<p>904102</p>  <p>PCS 4</p> <p>Ø44.5x2148</p>	<p>904389</p>  <p>PCS 1</p> <p>L 2148</p>	<p>904414</p>  <p>PCS 2</p> <p>L 515</p>
PCS	PCS	PCS	PCS	PCS	PCS
PCS	PCS	PCS	PCS	PCS	PCS
PCS	PCS	PCS	PCS	PCS	PCS
PCS	PCS	PCS	PCS	PCS	PCS

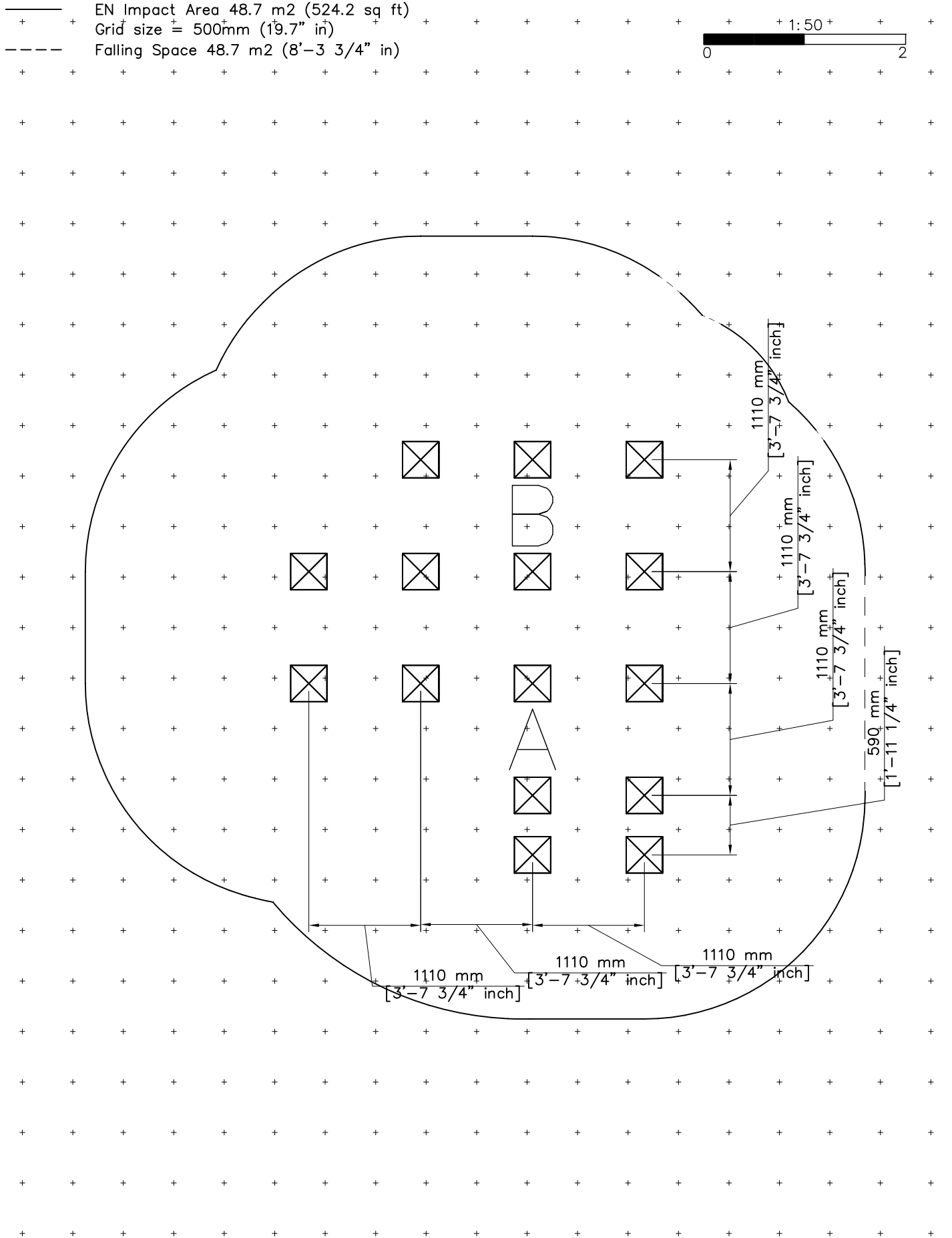

- EN Impact Area 48.7 (524.2 sq ft)
- - - - Falling Space 48.7 m2
- Max Falling Height 2530 mm (8'-3 3/4" in)

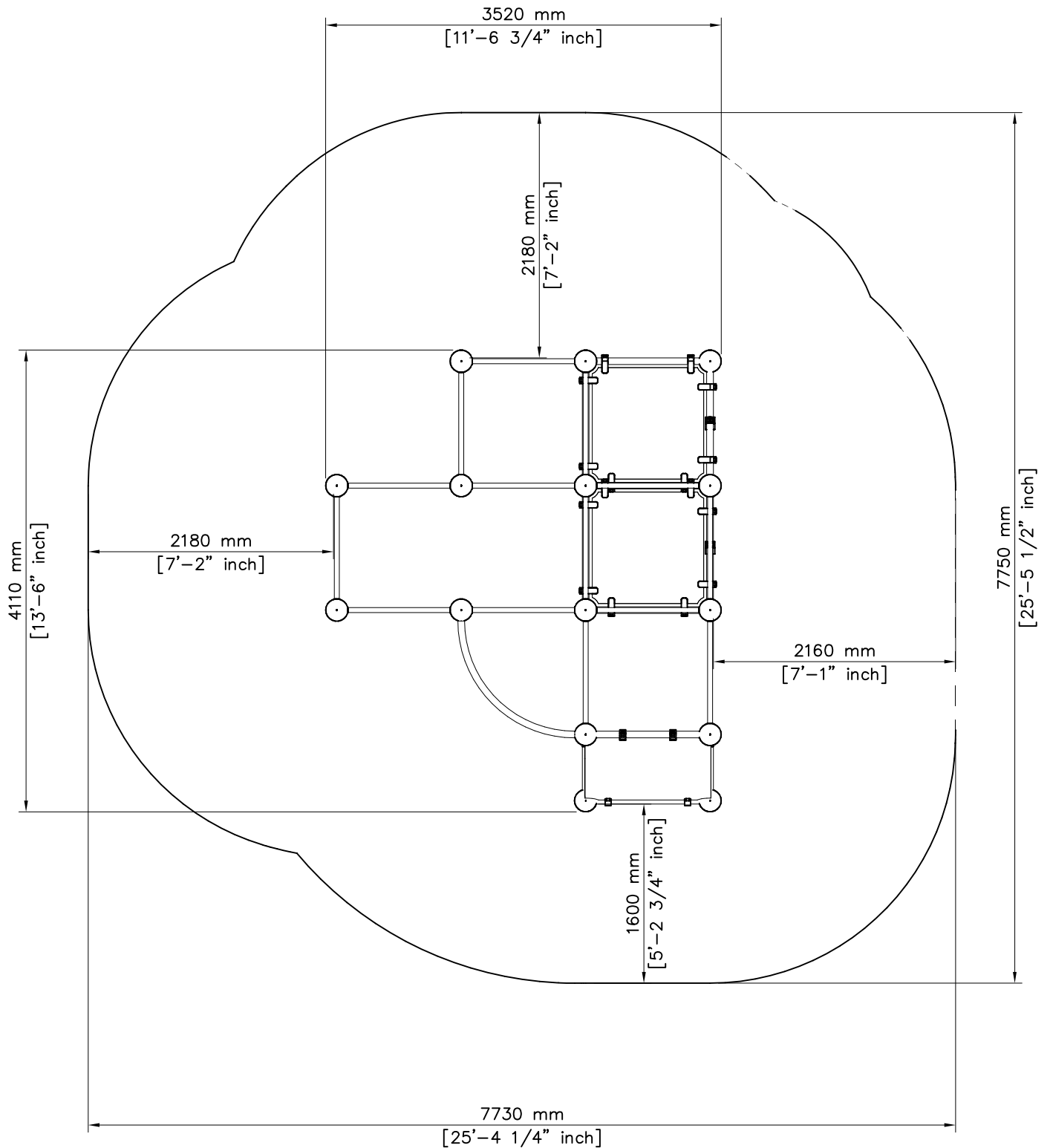
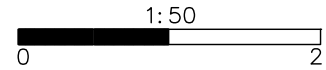

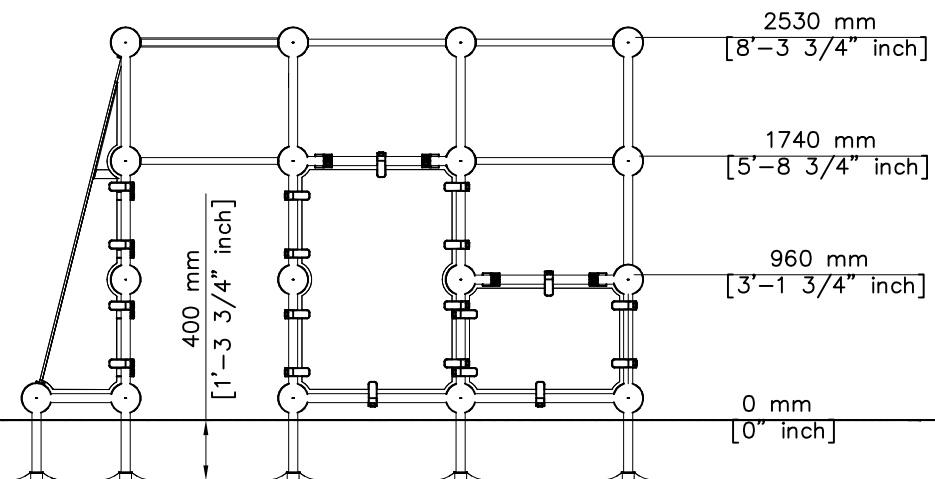
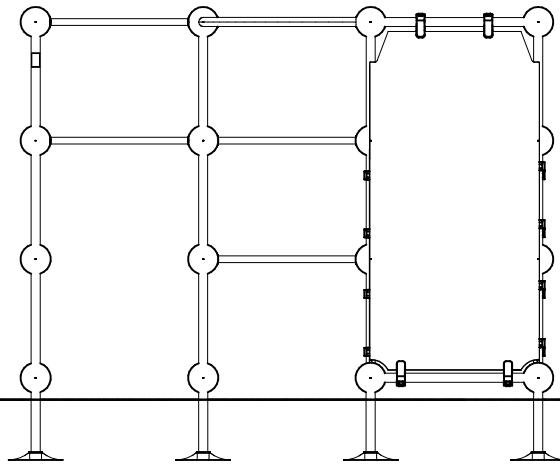

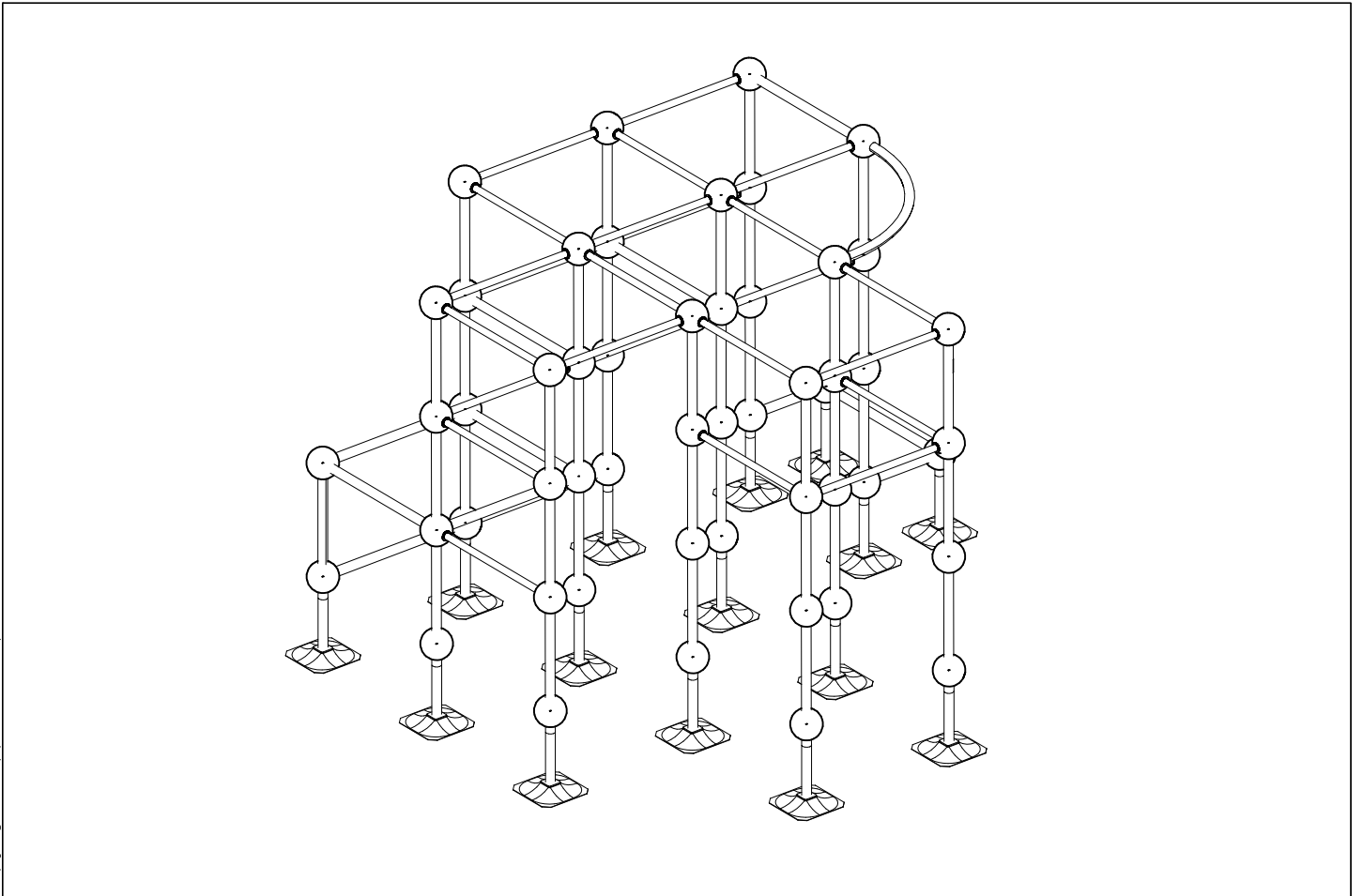
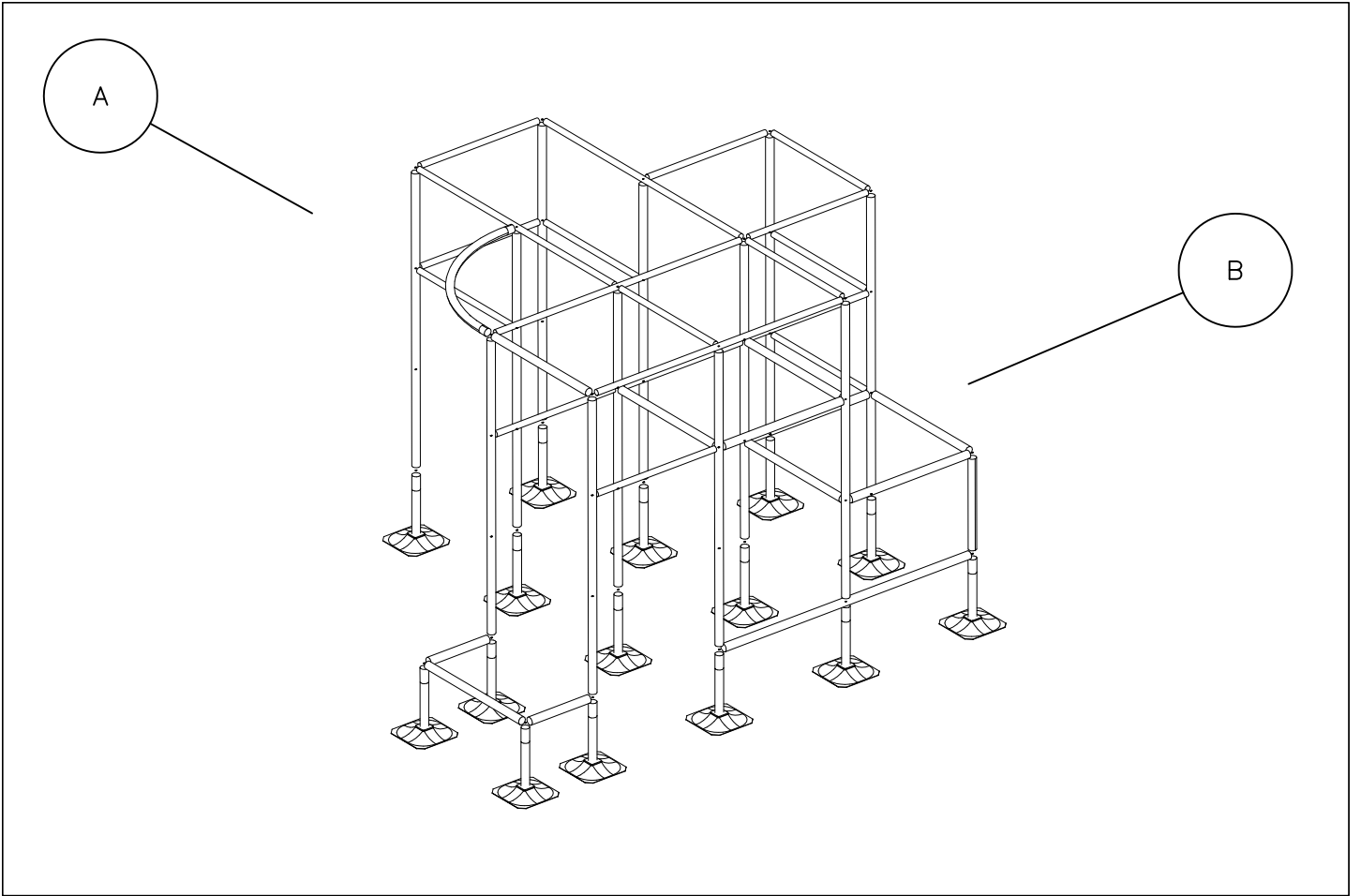

DATE: 19.3.2013

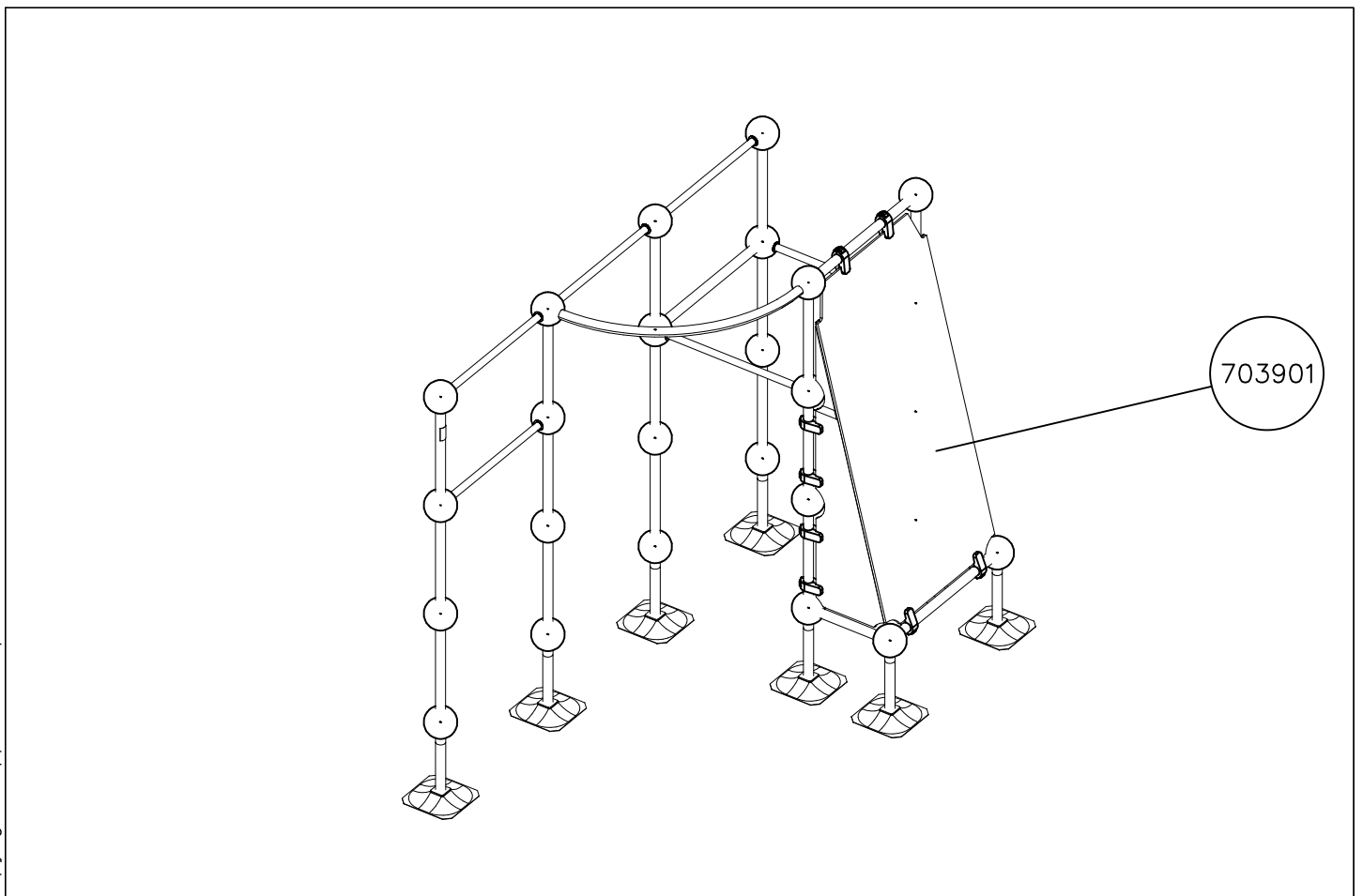
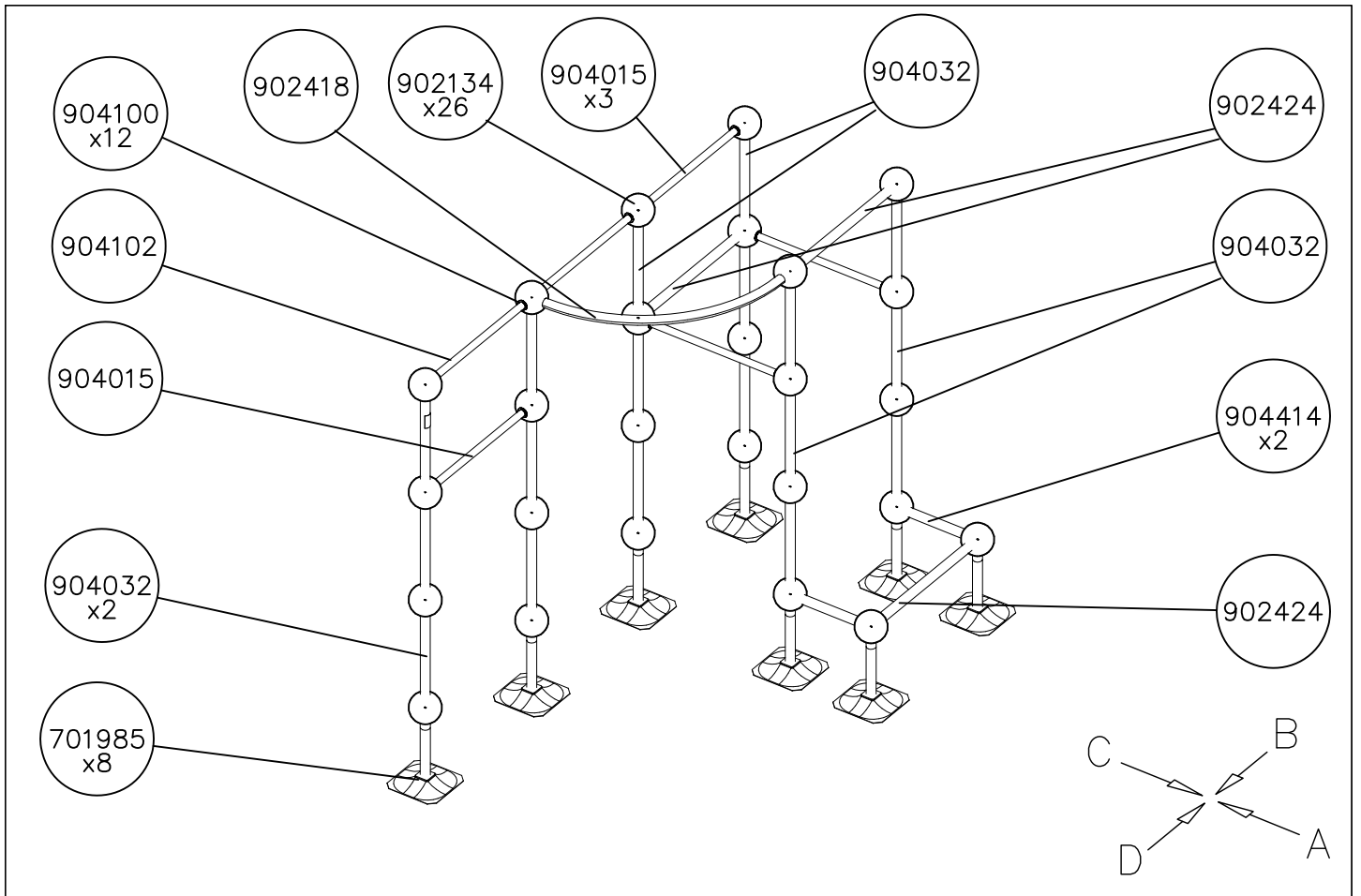

DATE: 19.3.2013

1:50

